



ZAVOD ZA
GRADBENIŠTVO
SLOVENIJE

SLOVENIAN
NATIONAL BUILDING
AND CIVIL ENGINEERING
INSTITUTE



član EOTA
Member of EOTA

Dimičeva 12
1000 Ljubljana, Slovenija

Tel.: +386 (0)1-280 44 72, 280 45 37
Fax: +386 (0)1-280 44 84
E-mail: info.ta@zag.si
<http://www.zag.si>

European Technical Assessment

ETA-17/0835
of 10.10.2017

English version prepared by ZAG

GENERAL PART

**Organ za tehnično ocenjevanje, ki je izdal
ETA**

Technical Assessment Body issuing the ETA

ZAG Ljubljana

Komercialno ime gradbenega proizvoda

Trade name of the construction product

EJOT concrete screw JC2

Družina proizvoda

Product family to which the construction product belongs

**33: Vijak za beton velikosti 6, 8 in 10 za
vgradnjo v razpokani in nerazpokani
beton**

**33: Concrete screw of size 6, 8 and 10 for use in
cracked and non-cracked concrete**

Proizvajalec
Manufacturer

EJOT Baubefestigungen GmbH
In der Stockwiese 35
57334 Bad Laasphe
Germany
www.ejot.com

Proizvodni obrat
Manufacturing plant

EJOT Plant 14

Ta Evropska tehnična ocena vsebuje

This European Technical Assessment contains

**13 strani vključno s 10 prilogami, ki so
sestavni del te ocene**
**13 pages including 10 annexes, which form an integral
part of the document**

**Ta Evropska tehnična ocena je izdana na
podlagi Uredbe (EU) št. 305/2011 na osnovi**

*This European Technical Assessment is issued in
accordance with Regulation (EU) No 305/2011, on the
basis of*

EAD 330232-00-0601, izdaja oktober 2016

EAD 330232-00-0601, edition October 2016

Translations of this European Technical Assessment in other languages shall fully correspond to the original issued document and should be identified as such.

Communication of this European Technical Assessment, including transmission by electronic means, shall be in full (excepted the confidential Annex(es) referred to above). However, partial reproduction may be made, with the written consent of the issuing Technical Assessment Body. Any partial reproduction has to be identified as such.

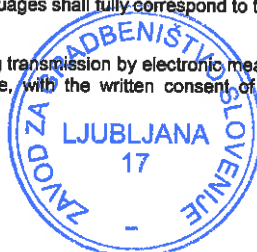

SPECIFIC PART OF THE EUROPEAN TECHNICAL ASSESSMENT

1 Technical description of the product

The EJOT concrete screw JC2 is an anchor in sizes 6, 8 and 10 made of galvanised steel. The anchor is screwed into a predrilled cylindrical hole. The special thread of the anchor cuts an internal thread into the member while setting. The anchorage is characterised by mechanical interlock in the special thread.

For the installed anchor see Figure given in Annex A1.

2 Specification of the intended use(s) in accordance with the applicable European Assessment Document (hereinafter EAD)

The performances given in Chapter 3 are only valid if the anchor is used in compliance with the specifications and conditions given in Annex B.

The provisions made in this European Technical Assessment are based on an assumed working life of the anchor of 50 years. The indications given on the working life cannot be interpreted as a guarantee given by the manufacturer, but are to be regarded only as a means for choosing the right products in relation to the expected economically reasonable working life of the works.

3 Performance of the product and references to the methods used for its assessment

3.1 Mechanical resistance and stability (BWR 1)

The basic work requirements for mechanical resistance and stability are listed in Annexes C1 and C2.

3.2 Safety in case of fire (BWR 2)

The basic work requirements for safety in case of fire are listed in Annexes C3 and C4.

3.3 Hygiene, health and environment (BWR 3)

Regarding dangerous substances contained in this European Technical Assessment, there may be requirements applicable to the products falling within its scope (e.g. transported European legislation and national laws, regulations and administrative provisions). In order to meet provisions of the regulation (EU) No 305/2011, these requirements need also to be complied with, when they apply.

3.4 Safety in use (BWR 4)

For basic work requirement safety in use the same criteria are valid as for basic work requirement mechanical resistance and stability.

3.5 Protection against noise (BWR 5)

Not relevant.

3.6 Energy economy and heat retention (BWR 6)

Not relevant.

3.7 Sustainable use of natural resources (BWR 7)

No performance assessed.

3.8 General aspects relating to fitness for use

Durability and serviceability are only ensured if specifications of intended use according to Annex B1 are kept.

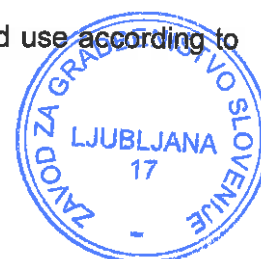

4 Assessment and verification of constancy of performance (hereinafter AVCP) system applied, with reference to its legal base

According to the decision 96/582/EC of the European Commission¹ the system of assessment and verification of constancy of performance (see Annex V to regulation (EU) No 305/2011) 1 apply.

5 Technical details necessary for the implementation of the AVCP system, as provided for on the applicable EAD

5.1 Tasks for the manufacturer

Technical details necessary for the implementation of the AVCP system are laid down in chapter 3 of EAD 330232-00-0601.

Issued in Ljubljana on 10. 10. 2017

Signed by:

Franc Capuder, M.Sc., Research Engineer

Head of Service of TAB

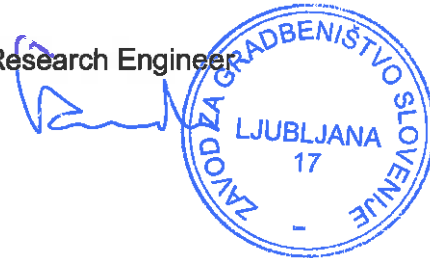

EJOT concrete screw JC2 after installation

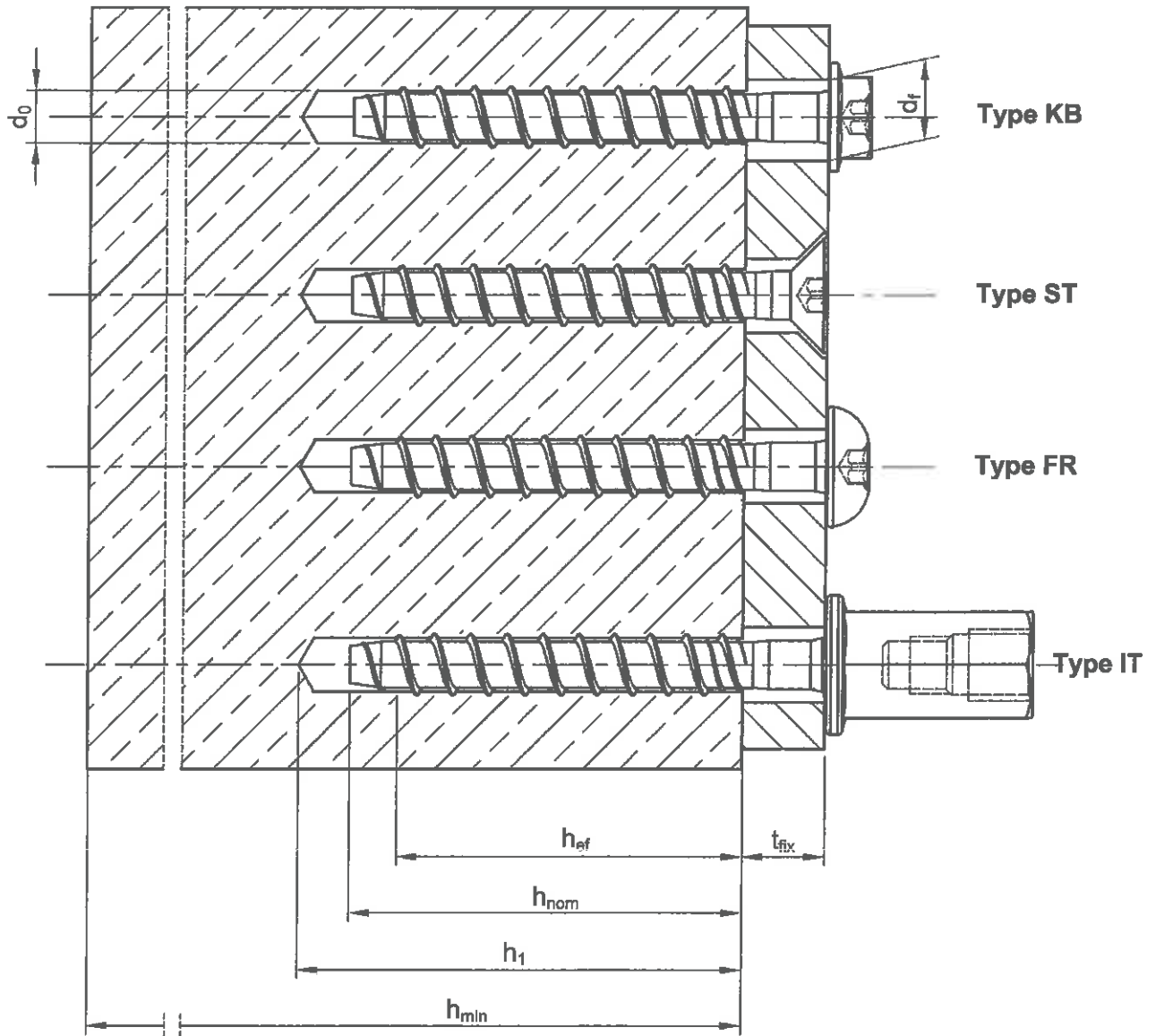

- d_0 = Drill hole diameter
- h_{nom} = Nominal embedment depth
- h_1 = Drill hole depth
- h_{min} = Minimum concrete member thickness
- t_{fix} = Fixture thickness
- d_f = Clearance hole diameter in fixture

EJOT concrete screw JC2

Product description
Installation condition

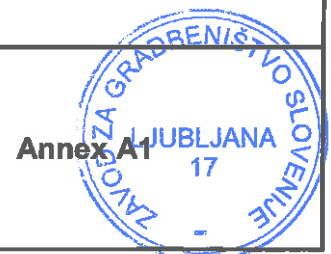

Table A1: Materials and Types

Material		f_{yk} [N/mm ²]	f_{uk} [N/mm ²]
Cold forged carbon steel, zinc electroplated according to EN ISO 4042 $\geq 5\mu\text{m}$		640	800
Part	Designation	Description	Design
1	JC2-KB	Hexagonal head version with combined washer and T-drive	
2	JC2-ST	Countersunk head version with T-drive	
3	JC2-FR	Pan head version with T-drive	
4	JC2-IT	Internal thread version with hexagonal drive	

Table A2: Anchor dimensions and head marking

Anchor size			JC2-6	JC2-8	JC2-10	Marking: Identifying mark: S or J Anchor identity: CSA or C2 Nominal diameter: d_{nom} Screw length: L Example: S-CSA 6x100 or: JC2-6x100
Nominal diameter	d_{nom}	[mm]	6	8	10	
Thread outer diameter	d_{th}	[mm]	7,45	9,90	11,9	
Core diameter	d_k	[mm]	5,50	7,30	9,3	
Shaft diameter	d_s	[mm]	5,88	7,80	9,62	
Stressed section	A_s	[mm ²]	23,76	41,85	67,9	



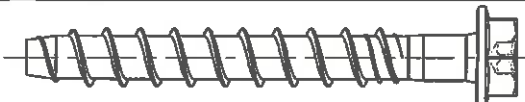
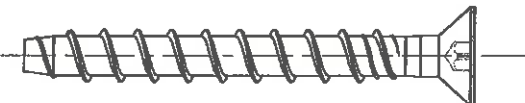
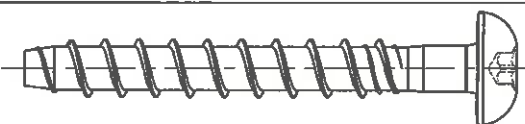
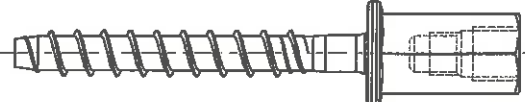
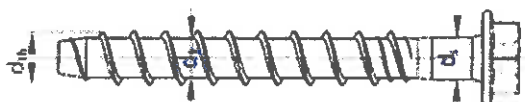
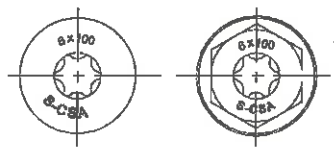

EJOT concrete screw JC2

Product description
Materials, types and dimensions

Annex A2



Specifications of intended use

Anchorage subjected to:

- Static, quasi static load.
- Fire exposure.

Base materials:

- Cracked and non-cracked concrete.
- Reinforced and unreinforced normal weight concrete of strength class C20/25 at minimum and C50/60 at maximum according to EN 206:2013+A1:2016.

Use conditions (Environmental conditions):

- The anchor may be used in concrete subject to dry internal conditions.

Design:

- Anchorages are designed under the responsibility of an engineer experienced in anchorages and concrete work.
- Anchorages under static and quasi-static actions are designed in accordance with EOTA TR 055, Edition December 2016 or CEN/TS 1992-4-4.
- For application with resistance under fire exposure the anchorages are designed in accordance with the method given in EOTA TR 020, Edition May 2004.
- Verifiable calculation notes and drawings are prepared taking into account of the load to be anchored. The position of the anchor is indicated on the design drawings (e.g. position of the anchor relative to reinforcement or to supports, etc.).

Installation:

- Anchor installation carried out by appropriately qualified personnel and under the supervision of the person responsible for technical matters on the site.
- Use of the anchor only as supplied by the manufacturer without exchanging the components of an anchor.
- Anchor installation in accordance with the manufacturer's specifications and drawings using the appropriate tools.
- Checks before placing the anchor to ensure that the strength class of the concrete in which the anchor is to be placed is in the range given and is not lower than that of the concrete to which the characteristic loads apply for.
- Check of concrete being well compacted, e.g. without significant voids.
- Cleaning of the hole of drilling dust.
- Anchor installation ensuring the specified embedment depth.
- Keeping of the edge distance and spacing to the specified values without minus tolerances.
- Positioning of the drill holes without damaging the reinforcement.
- In case of aborted hole, drilling of new hole at a minimum distance of twice the depth of the aborted hole, or smaller distance provided the aborted drill hole is filled with high strength non-shrinkage mortar. No shear or oblique tension loads are allowed in the direction of a not filled aborted hole.
- Application of the torque moment given in Annex B2 using a calibrated torque wrench.

EJOT concrete screw JC2

**Intended use
Specifications**

Annex B1

LJUBLJANA
17

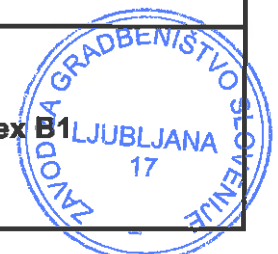

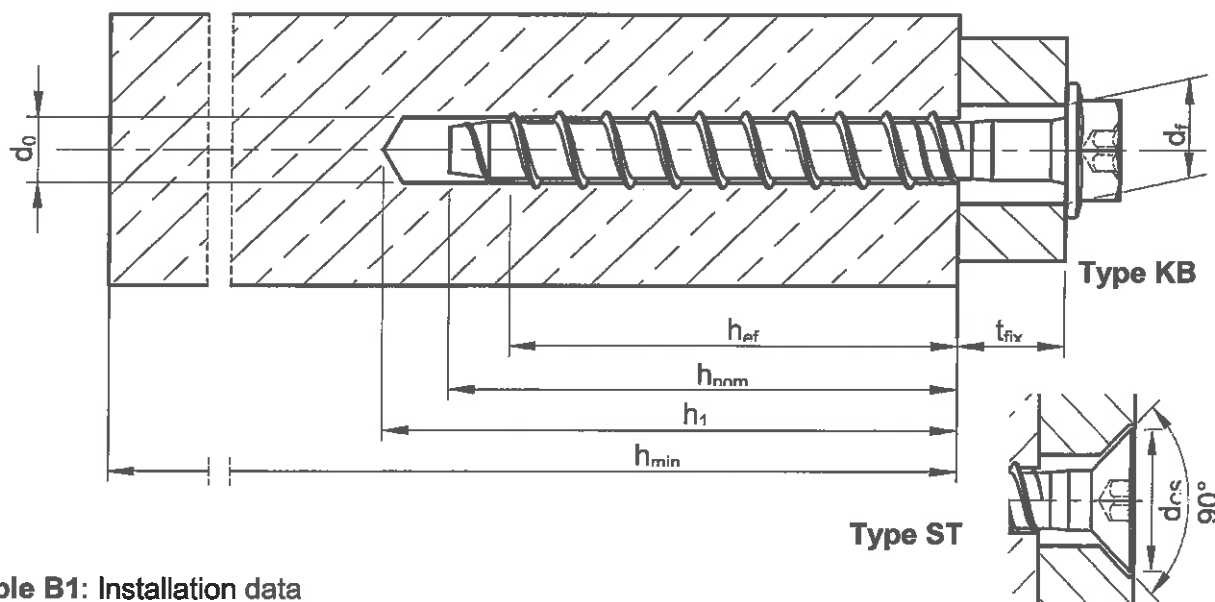

Table B1: Installation data

EJOT concrete screw JC2		Anchor size		
		JC2-6	JC2-8	JC2-10
Nominal embedment depth	h_{nom} [mm]	55	65	85
Drill hole diameter	d_0 [mm]	6	8	10
Cutting diameter at the upper tolerance limit (maximum diameter bit)	$d_{cut,max} \leq$ [mm]	6,40	8,45	10,45
Depth of drilled hole to deepest point	$h_1 \geq$ [mm]	65	75	95
Effective anchorage depth	h_{ef} [mm]	42,5	48,5	61,5
Diameter of clearance hole in the fixture	$d_f \leq$ [mm]	9	12	14
Countersunk head diameter (Type CS)	d_{cs} [mm]	14	-	-
T-drive	T [-]	30	40	-
Width across flats	SW [mm]	11	13	15
Required torque	T_{inst} [Nm]	14	40	90
Max installation torque for impact screw driver	T_{SD} [Nm]	90	200	500

Table B2: Minimum thickness of concrete member, spacing and edge distance

EJOT concrete screw JC2		Anchor size		
		JC2-6	JC2-8	JC2-10
Minimum thickness of concrete member	h_{min} [mm]	100	110	125
Minimum spacing	s_{min} [mm]	35	50	50
Minimum edge distance	c_{min} [mm]	35	50	50

EJOT concrete screw JC2

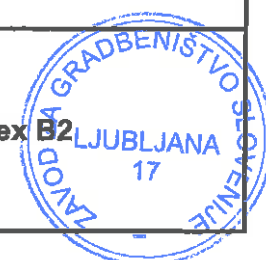
Intended use
Installation dataAnnex B2 Ljubljana
17

Installation instructions

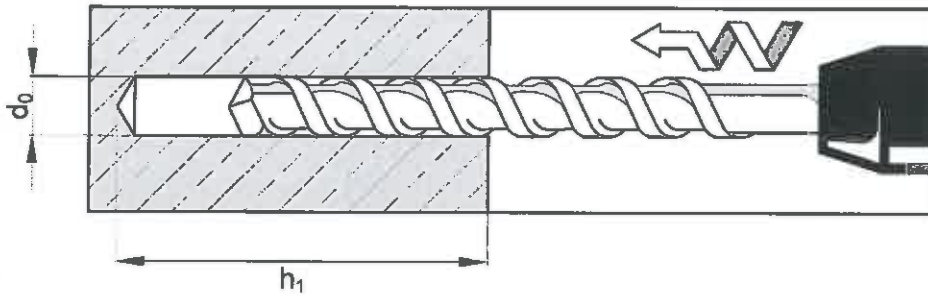

Make a cylindrical hole

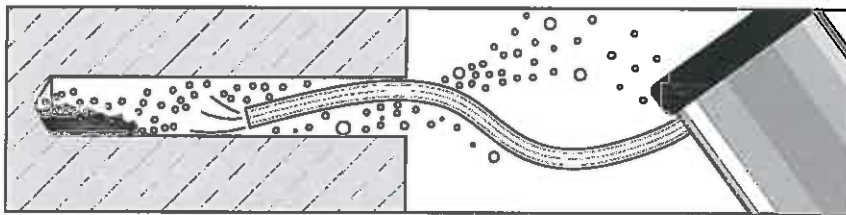

Clean the hole

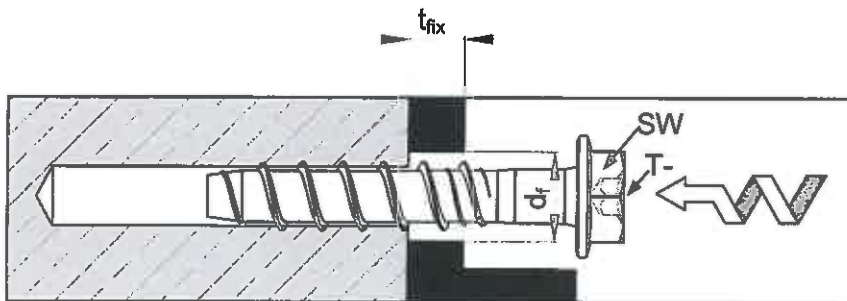

Install the screw anchor by impact screwdriver or torque wrench

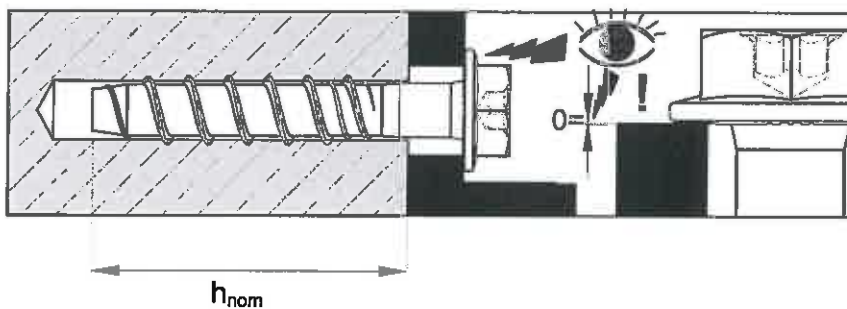

Ensure that the screw anchor head fully rests without any gap on the fixture and is not damaged

EJOT concrete screw JC2

Intended use
Installation instructions

Annex B3



Table C1: Characteristic resistances under tension loads in case of static and quasi-static loading for design according EOTA TR 055 or CEN/TS 1992-4-4

EJOT concrete screw JC2			Anchor size		
			JC2-6	JC2-8	JC2-10
Steel failure					
Characteristic resistance	$N_{Rk,s}$	[kN]	19,1	33,5	54,3
Partial safety factor	$\gamma_{Ms}^{1)}$	[-]	1,5		
Pull-out failure					
Characteristic resistance in cracked concrete C20/25	$N_{Rk,p}$	[kN]	3	4	7
Characteristic resistance in non-cracked concrete C20/25	$N_{Rk,p}$	[kN]	6	8	19
Increasing factor for $N_{Rk,p}$	Ψ_C	C25/30	1,01	1,00	1,06
		C30/37	1,03	1,00	1,14
		C35/45	1,06	1,00	1,22
		C40/50	1,07	1,00	1,26
		C45/55	1,09	1,00	1,31
		C50/60	1,10	1,00	1,35
Partial safety factor	γ_{inst}	[-]	1,2		
	$\gamma_{Mp}^{1)}$	[-]	1,8 ²⁾		
Concrete cone and splitting failure					
Effective anchorage depth	h_{ef}	[mm]	42,5	48,5	61,5
Factor for cracked concrete	k_{cr}	[-]	7,2		
Factor for non-cracked concrete	k_{ucr}	[-]	10,1		
Spacing	$s_{cr,N}$	[mm]	128	146	184
Edge distance	$c_{cr,N}$	[mm]	64	73	92
Spacing (splitting)	$s_{cr,sp}$	[mm]	128	146	184
Edge distance (splitting)	$c_{cr,sp}$	[mm]	64	73	92
Partial safety factor	$\gamma_{Msp}^{1)}$	[-]	1,8 ²⁾		

¹⁾ In absence of other national regulations

²⁾ The installation safety factor of $\gamma_2 = 1,2$ is included

EJOT concrete screw JC2

Performance

Characteristic resistance under tension loads

Annex C1



Table C2: Characteristic resistances under shear loads in case of static and quasi-static loading for design according to EOTA TR 055 or **CEN/TS 1992-4-4**

EJOT concrete screw JC2			Anchor size		
			JC2-6	JC2-8	JC2-10
Steel failure without lever arm					
Characteristic resistance	$V_{Rk,s}$	[kN]	9,8	14,2	29,1
Partial safety factor	$\gamma_{Ms}^{1)}$	[-]	1,25		
Factor for considering ductility	k_2	[-]	0,8		
Steel failure with lever arm					
Characteristic resistance	$M_{Rk,s}^0$	[Nm]	16	37	76
Partial safety factor	$\gamma_{Ms}^{1)}$	[-]	1,25		
Concrete pryout failure					
k-factor	$k_{(3)}$	[-]	1,0	2,0	
Partial safety factor	$\gamma_{Mc}^{1)}$	[-]	1,5		
Concrete edge failure					
Effective length of anchor under shear load	l_f	[mm]	42,5	48,5	61,5
Outside diameter of anchor	d_{nom}	[mm]	6	8	10
Cracked concrete without any edge reinforcement	$\psi_{ucr,v}$	[-]	1,0		
Cracked concrete with straight edge reinforcement > Ø12 mm			1,2		
Cracked concrete with edge reinforcement and closely spaced stirrups ($a \leq 100\text{mm}$) or non-cracked concrete			1,4		
Partial safety factor			$\gamma_{Mc}^{1)}$	[-]	1,5

¹⁾ In absence of other national regulations

EJOT concrete screw JC2

Performance

Characteristic resistance under shear loads

Annex C2



Table C3: Characteristic resistances under tension loads in case of fire exposure for design according to EOTA TR 020

EJOT concrete screw JC2			Anchor size		
			JC2-6	JC2-8	JC2-10
Steel failure					
Characteristic resistance $N_{Rk,s,fi}$	R30	[kN]	0,24	0,42	1,02
	R60	[kN]	0,22	0,38	0,88
	R90	[kN]	0,17	0,29	0,68
	R120	[kN]	0,12	0,21	0,54
Pull-out failure					
Characteristic resistance $N_{Rk,p,fi}$	R30	[kN]	0,75	1,00	1,75
	R60	[kN]	0,75	1,00	1,75
	R90	[kN]	0,75	1,00	1,75
	R120	[kN]	0,60	0,80	1,40
Concrete cone and splitting failure ¹⁾					
Characteristic resistance $N^0_{Rk,c,fi}$	R30	[kN]	2,12	2,95	5,34
	R60	[kN]	2,12	2,95	5,34
	R90	[kN]	2,12	2,95	5,34
	R120	[kN]	1,70	2,36	4,27
Spacing	$s_{cr,N,fi}$	[mm]	4 x h_{ef}		
	s_{min}	[mm]	35	50	50
Edge distance	$c_{cr,N,fi}$	[mm]	2 x h_{ef}		
	c_{min}	[mm]	Fire attack from one side: $c_{min} = 2 \times h_{ef}$ Fire attack from more than one side: $c_{min} \geq 300 \text{ mm}$ and $\geq 2 \times h_{ef}$		

¹⁾ As a rule, splitting failure can be neglected when cracked concrete and reinforcement is assumed

Design under fire exposure is performed according to the design method given in EOTA TR 020.

Under fire exposure usually cracked concrete is assumed. The design equations are given in EOTA TR 020 § 2.2.1.

In the absence of other national regulations the partial safety factor for resistance under fire exposure $\gamma_{M,fi} = 1,0$ is recommended.

EJOT concrete screw JC2

Performance

Characteristic tension resistance under fire exposure

Annex C3



Table C4: Characteristic resistances under shear loads in case of fire exposure for design according to EOTA TR 020

EJOT concrete screw JC2			Anchor size		
			JC2-6	JC2-8	JC2-10
Steel failure without lever arm					
Characteristic resistance $V_{Rk,s,fi}$	R30	[kN]	0,24	0,42	1,02
	R60	[kN]	0,22	0,38	0,88
	R90	[kN]	0,17	0,29	0,68
	R120	[kN]	0,12	0,21	0,54
Steel failure with lever arm					
Characteristic resistance $M^0_{Rk,s,fi}$	R30	[Nm]	0,19	0,46	1,42
	R60	[Nm]	0,18	0,41	1,23
	R90	[Nm]	0,14	0,32	0,95
	R120	[Nm]	0,10	0,23	0,76
Concrete pryout failure					
k-factor	$k_{(3)}$	[-]	1,0		2,0
Characteristic resistance $V_{Rk,cp,fi}$	R30	[kN]	2,12	2,95	10,68
	R60	[kN]	2,12	2,95	10,68
	R90	[kN]	2,12	2,95	10,68
	R120	[kN]	1,70	2,36	8,54
Concrete edge failure					
The initial value $V^0_{Rk,c,fi}$ of the characteristic resistance in concrete C20/25 to C50/60 under fire exposure may be determined by:					
$V^0_{Rk,c,fi} = 0,25 \times V^0_{Rk,c} \quad (\leq R90) \qquad V^0_{Rk,c,fi} = 0,20 \times V^0_{Rk,c} \quad (R120)$					
with $V^0_{Rk,c}$ initial value of the characteristic resistance in cracked concrete C20/25 under normal temperature.					

Design under fire exposure is performed according to the design method given in EOTA TR 020.

Under fire exposure usually cracked concrete is assumed. The design equations are given in EOTA TR 020 § 2.2.1.

EOTA TR 020 covers design for fire exposure from one side. For fire attack from more than one side the edge distance must be increased to $c_{min} \geq 300$ mm and $\geq 2 \times h_{ef}$.

In the absence of other national regulations the partial safety factor for resistance under fire exposure $\gamma_{M,fi} = 1,0$ is recommended.

EJOT concrete screw JC2

Performance

Characteristic shear resistance under fire exposure



Table C5: Displacements under tension loads for static and quasi-static loading

EJOT concrete screw JC2			Anchor size		
			JC2-6	JC2-8	JC2-10
Cracked C20/25	N	[kN]	1,2	1,6	2,8
	δ_{N0}	[mm]	0,06	0,08	0,08
	$\delta_{N\infty}$	[mm]	0,60	0,52	0,61
Cracked C50/60	N	[kN]	1,3	1,6	3,7
	δ_{N0}	[mm]	0,04	0,04	0,09
	$\delta_{N\infty}$	[mm]	0,60	0,52	0,61
Non-cracked C20/25	N	[kN]	2,4	3,2	7,5
	δ_{N0}	[mm]	0,04	0,01	0,04
	$\delta_{N\infty}$	[mm]	0,60	0,52	0,61
Non-cracked C50/60	N	[kN]	2,6	3,2	10
	δ_{N0}	[mm]	0,01	0,02	0,07
	$\delta_{N\infty}$	[mm]	0,60	0,52	0,61

Table C6: Displacements under shear loads for static and quasi-static loading

EJOT concrete screw JC2			Anchor size		
			S-CSA 6	S-CSA 8	S-CSA 10
Cracked and non-cracked concrete C20/25 - C50/60	V	[kN]	5,6	8,1	16,6
	δ_{V0}	[mm]	1,11	1,55	2,52
	$\delta_{V\infty}$	[mm]	1,66	2,33	3,78

EJOT concrete screw JC2

Performance

Displacements under tension and shear loads

Annex C5

